



EconoComp™ Product

PRICE ADJUSTMENT

EFFECTIVE MARCH 1, 2009

Mill Finish Extrusions & Kits.....	-5%
Pre-Painted Extrusions & Kits.....	-5%
All Accessories and Components.....	-5%

Please contact your SignComp Customer Service Representative for exact pricing.

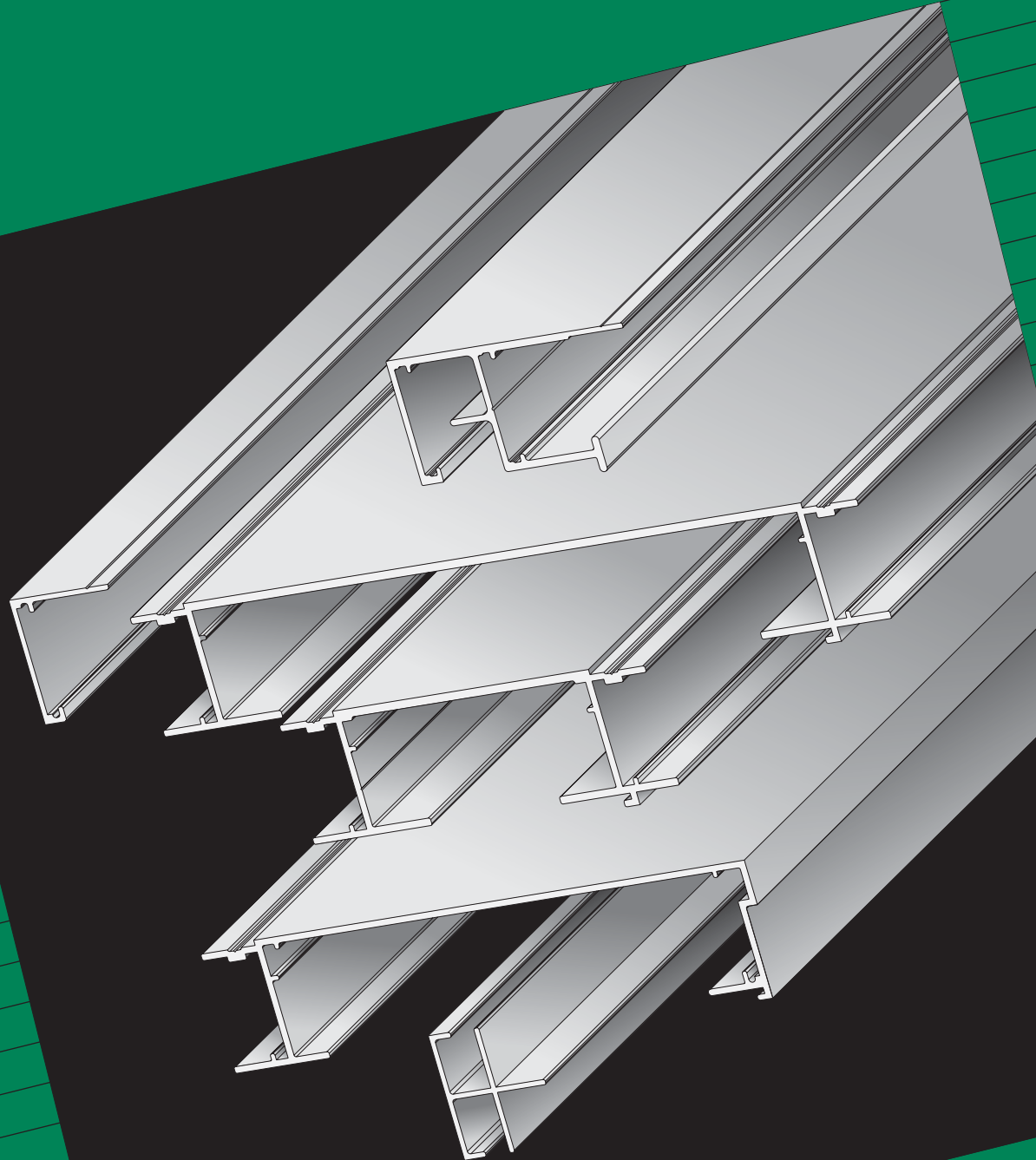

2008





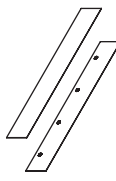
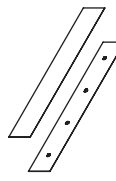
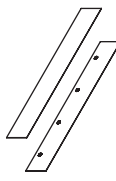
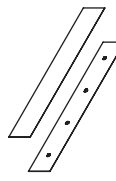
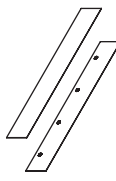
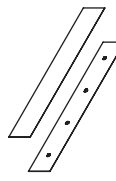
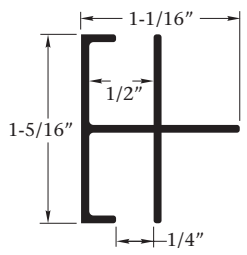
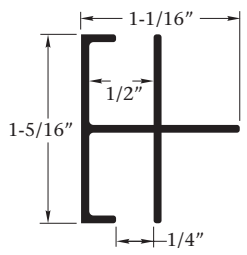
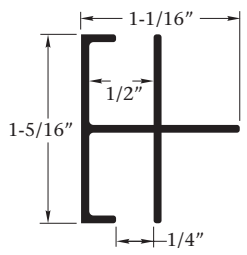



Sign Cabinet Kits



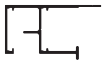

General Information	<ul style="list-style-type: none"> □ The filler and molding shall be cut 1" longer than the nominal T-12 lamp size for horizontal or vertical lamping. □ General guideline for T-12 lamp spacing: Double the distance between the front of the lamp and the back of the plastic face for your center to center lamp measurement. Maximum center to center is typically 12". □ Extrusion fillers and moldings are engineered for mechanical fastening assembly. □ Extended Econo Molding, part #2058, is not engineered to directly integrate with the Econo Divider, Part #2140. Minimal additional assembly is required using the Extended Divider Angle, part #5335. See page 11 □ Additional information. See below 																
Included in Kit Pricing	<ul style="list-style-type: none"> □ Mill finish or Pre-painted. □ Cut to size and mitered filler extrusion. □ Cut to size and mitered molding extrusion. □ All screws required to assemble by mechanical fastening. □ Corner Keys required. □ Packaging. 																
Not Included in Kit Pricing	<ul style="list-style-type: none"> □ Faces. □ Single Face Filler kits do not include aluminum backs. □ Raceway Covers. □ Ballast Brackets. □ Corner Angles - Not required for assembly. □ Econo Divider. See below 																
Mill Finish	<ul style="list-style-type: none"> □ No prior surface preparation. Surface scratches, die lines and imperfections present. □ Not ready for paint. 																
Pre-Painted	<ul style="list-style-type: none"> □ Exposed aluminum surfaces are coated with Quaker Dark Bronze primer/topcoat. □ Limited additional colors are available, minimum order will apply. 																
Pricing	<ul style="list-style-type: none"> □ All prices are effective as of March 1, 2007. Due to fluctuation in the raw aluminum market, prices are subject to change without notice. □ Packaging is included in listed prices. □ Freight. See freight policy page 11 																
Raceway Covers	<table border="0" style="width: 100%;"> <tr> <td style="width: 20%; text-align: center;">  </td> <td style="width: 30%;"> Single Face Raceway Cover 5-1/8" x 48" x .040" (white) Pre-Punched 7" on Center Pre-Punched 10" on Center Blank </td> <td style="width: 10%; text-align: center;"> Part Number 5082 5083 5084 </td> <td style="width: 10%; text-align: center;"> Price Each \$11.32 \$11.32 \$6.47 </td> <td style="width: 20%; text-align: center;">  </td> <td style="width: 10%;"> Medium Double Face Raceway Cover 3" x 48" x .040" (white) Blank </td> <td style="width: 10%; text-align: center;"> Part Number 5085 </td> <td style="width: 10%; text-align: center;"> Price Each \$14.56 </td> </tr> <tr> <td></td> <td> Large Double Face Raceway Cover 6-1/2" x 48" x .040" (white) Pre-Punched 7" on Center Pre-Punched 10" on Center Blank </td> <td style="text-align: center;"> 5086 5087 5088 </td> <td style="text-align: center;"> \$14.56 \$14.56 \$8.41 </td> <td></td> <td></td> <td></td> <td></td> </tr> </table>		Single Face Raceway Cover 5-1/8" x 48" x .040" (white) Pre-Punched 7" on Center Pre-Punched 10" on Center Blank	Part Number 5082 5083 5084	Price Each \$11.32 \$11.32 \$6.47		Medium Double Face Raceway Cover 3" x 48" x .040" (white) Blank	Part Number 5085	Price Each \$14.56		Large Double Face Raceway Cover 6-1/2" x 48" x .040" (white) Pre-Punched 7" on Center Pre-Punched 10" on Center Blank	5086 5087 5088	\$14.56 \$14.56 \$8.41				
	Single Face Raceway Cover 5-1/8" x 48" x .040" (white) Pre-Punched 7" on Center Pre-Punched 10" on Center Blank	Part Number 5082 5083 5084	Price Each \$11.32 \$11.32 \$6.47		Medium Double Face Raceway Cover 3" x 48" x .040" (white) Blank	Part Number 5085	Price Each \$14.56										
	Large Double Face Raceway Cover 6-1/2" x 48" x .040" (white) Pre-Punched 7" on Center Pre-Punched 10" on Center Blank	5086 5087 5088	\$14.56 \$14.56 \$8.41														
Cut To Size Econo Divider	<table border="0" style="width: 100%;"> <tr> <td style="width: 25%; text-align: center;">  </td> <td style="width: 30%;"> Part 1-5/16" Econo Divider </td> <td style="width: 10%; text-align: center;"> Part Number 2140 </td> <td style="width: 10%; text-align: center;"> Cut to Size Mill Finish \$2.97 </td> <td style="width: 15%; text-align: center;"> Cost Per Foot Pre-Painted \$3.85 </td> </tr> </table>		Part 1-5/16" Econo Divider	Part Number 2140	Cut to Size Mill Finish \$2.97	Cost Per Foot Pre-Painted \$3.85											
	Part 1-5/16" Econo Divider	Part Number 2140	Cut to Size Mill Finish \$2.97	Cost Per Foot Pre-Painted \$3.85													
Cut To Size Econo Divider Includes	<ul style="list-style-type: none"> □ Divider Screws, part #5217, for mechanical fastening. □ Divider Corner Angle 1" x 1" x 1/8" (1/2"), part #5325, for use with Econo Molding. □ Extended Divider Corner Angle 1" x 1" x 1/8" (2-1/4"), part #5335, for use with Extended Econo Molding. 																



EconoComp Extrusion Prices by the Length

	Part	Part Number	Length	Mill Finish	Pre-painted
Sign Cabinet Fillers					
  	Large Double Face Filler	2032	24' 5"	\$125.92 <i>Cost per Foot</i> 5.16	\$163.43 6.69
	Medium Double Face Filler	2036	24' 5"	85.30 <i>Cost per Foot</i> 3.49	110.71 4.53
	Single Face Filler	2034	24' 5"	85.71 <i>Cost per Foot</i> 3.51	111.24 4.56
Moldings					
 	Econo Molding	2056	24' 5"	17.60 <i>Cost per Foot</i> 0.72	22.86 0.94
	Extended Econo Molding	2058	24' 5"	54.52 <i>Cost per Foot</i> 2.23	69.65 2.85
Divider					
	1-5/16" Econo Divider	2140	24' 5"	40.45 <i>Cost per Foot</i> 1.66	53.86 2.21

EconoComp Accessories

	Part	Part Number	Price Each
Components			
	Corner Key .120 Stamped Aluminum	5210	\$0.70 Each
	Divider Angle for Econo Molding 1" x 1" x 1/8" (1/2")	5325	0.87 Each
	Extended Divider Angle for Extended Econo Molding 1" x 1" x 1/8" (1-1/8")	5335	1.02 Each
Hardware			
	Molding Screw	5217	15.00/100
	Corner Key Screw		
	Divider Screw		
	Molding Screw Pre-painted #8 x 1/2" coated hex washer self drilling/tapping screw - type A	5217P	19.00/100

EconoComp Configurations

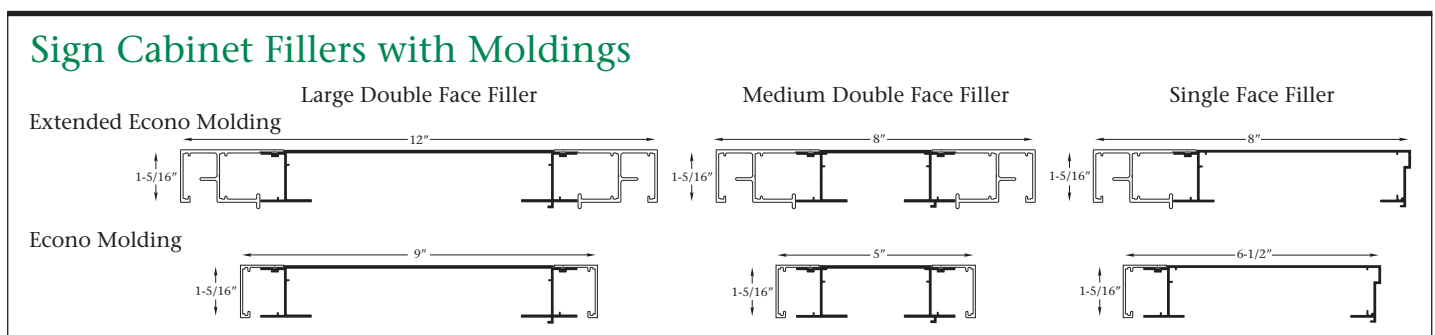



Unassembled 6-1/2" Single Face Kits - For Rigid Faces

Single Face Filler with Econo Molding

Part #2034

Part #2056

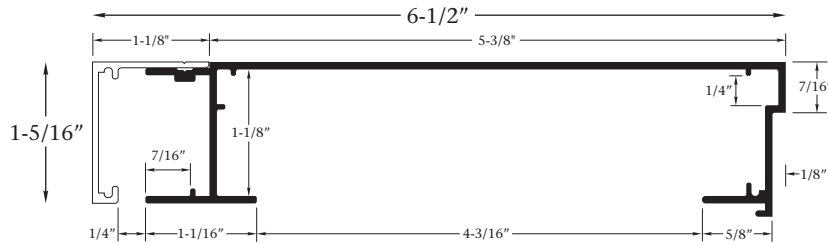

Size H x W	Mill Finish	Pre- Paint	Size H x W	Mill Finish	Pre- Paint	Size H x W	Mill Finish	Pre- Paint	Size H x W	Mill Finish	Pre- Paint	Size H x W	Mill Finish	Pre- Paint
1 x 1	\$48	\$56	1.5 x 3.5	\$83	\$102	2 x 13	\$203	\$257	3 x 9	\$168	\$211	4 x 9	\$180	\$227
1 x 2	60	72	1.5 x 4	90	109	2 x 14	216	273	3 x 10	180	227	4 x 10	192	243
1 x 3	72	87	1.5 x 5	102	125	2 x 15	228	289	3 x 11	192	243	4 x 11	203	257
1 x 4	83	102	1.5 x 6	113	141	2.5 x 2.5	83	102	3 x 12	203	257	4 x 12	216	273
1 x 5	96	118	1.5 x 8	138	172	2.5 x 3	90	109	3 x 13	216	273	4 x 13	228	289
1 x 6	108	133	1.5 x 10	162	203	2.5 x 3.5	96	118	3 x 14	228	289	4 x 14	240	304
1 x 7	120	149	2 x 2	72	87	2.5 x 4	102	125	3 x 15	240	304	4 x 15	251	320
1 x 8	132	165	2 x 2.5	78	95	2.5 x 5	113	141	3.5 x 3.5	108	133	5 x 5	143	180
1 x 9	143	180	2 x 3	83	102	2.5 x 6	126	156	3.5 x 4	113	141	5 x 6	156	196
1 x 10	156	196	2 x 3.5	90	109	2.5 x 8	150	188	3.5 x 5	126	156	5 x 7	168	211
1 x 11	168	211	2 x 4	96	118	2.5 x 10	173	219	3.5 x 6	138	172	5 x 8	180	227
1 x 12	180	227	2 x 5	108	133	3 x 3	96	118	3.5 x 8	162	203	5 x 9	192	243
1 x 13	192	243	2 x 6	120	149	3 x 3.5	102	125	3.5 x 10	186	234	5 x 10	203	257
1 x 14	203	257	2 x 7	132	165	3 x 4	108	133	4 x 4	120	149	5 x 11	216	273
1 x 15	216	273	2 x 8	143	180	3 x 5	120	149	4 x 5	132	165	5 x 12	228	289
1.5 x 1.5	60	72	2 x 9	156	196	3 x 6	132	165	4 x 6	143	180	6 x 6	168	211
1.5 x 2	66	79	2 x 10	168	211	3 x 7	143	180	4 x 7	156	196	6 x 7	180	227
1.5 x 2.5	72	87	2 x 11	180	227	3 x 8	156	196	4 x 8	168	211	6 x 8	192	243
1.5 x 3	78	95	2 x 12	192	243									

Included in Sign Cabinet Kit Pricing:

- Mill finish or Pre-painted.
- Four (4) pieces of cut to size and mitered Single Face Filler, Part #2034.
- Four (4) pieces of cut to size and mitered Econo Molding, Part #2056.
- Twelve (12) Corner Keys, Part #5210.
- Thirty-two (32) Corner Key Screws, Part #5217.
- One (1) Molding Screws, Part #5217 for every perimeter foot of Econo Molding.
- Packaging.

Kit Sizes and Availability:

- It is recommended to order kits 1" over nominal T-12 lamp size to utilize .040 Flat Aluminum Raceway Covers.
- Custom size kits may be cut to any dimension.

Recommended Lamp Spacing:

- For flat plastic, illuminated backgrounds - 7" on center, using T-12 lamps.
- For pan formed faces use guideline for T-12 lamp spacing, see General Information on page 2.
- Always place lamps 3/4" from back of sign.

Not included in Sign Cabinet Kit Pricing:

- Face and Back.
- Raceway Covers.
- Raceway Cover Screws.
- Ballast Brackets.
- Corner Angles - Not required for assembly.
- Electrical Components.
- Structural Supports.

General Information:

- Finishes: See page 2.
- Additional information: See page 2.
- Cut to size and pre-cut kits are available locally through select sign supply distributors.
- Designed for use with Econo Divider: See page 11.



Unassembled 8" Single Face Kits - For Rigid Faces

Single Face Filler with Extended Econo Molding

Part #2034

Part #2058

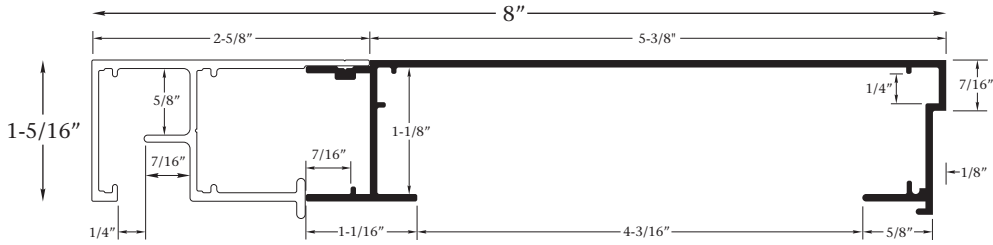

Size H x W	Mill Finish	Pre- Paint	Size H x W	Mill Finish	Pre- Paint	Size H x W	Mill Finish	Pre- Paint	Size H x W	Mill Finish	Pre- Paint	Size H x W	Mill Finish	Pre- Paint
1 x 1	\$61	\$72	1.5 x 3.5	\$112	\$138	2 x 13	\$ 282	\$358	3 x 9	\$232	\$292	4 x 9	\$249	\$314
1 x 2	78	93	1.5 x 4	121	149	2 x 14	301	380	3 x 10	249	314	4 x 10	266	336
1 x 3	96	116	1.5 x 5	138	171	2 x 15	318	401	3 x 11	266	336	4 x 11	282	358
1 x 4	112	138	1.5 x 6	156	194	2.5 x 2.5	112	138	3 x 12	282	358	4 x 12	301	380
1 x 5	129	161	1.5 x 8	189	236	2.5 x 3	121	149	3 x 13	301	380	4 x 13	318	401
1 x 6	147	182	1.5 x 10	224	280	2.5 x 3.5	129	161	3 x 14	318	401	4 x 14	334	424
1 x 7	164	204	2 x 2	96	116	2.5 x 4	138	171	3 x 15	334	424	4 x 15	351	445
1 x 8	181	225	2 x 2.5	104	126	2.5 x 5	156	194	3.5 x 3.5	147	182	5 x 5	198	247
1 x 9	198	247	2 x 3	112	138	2.5 x 6	172	215	3.5 x 4	156	194	5 x 6	214	270
1 x 10	214	270	2 x 3.5	121	149	2.5 x 8	207	259	3.5 x 5	172	215	5 x 7	232	292
1 x 11	232	292	2 x 4	129	161	2.5 x 10	241	303	3.5 x 6	189	236	5 x 8	249	314
1 x 12	249	314	2 x 5	147	182	3 x 3	129	161	3.5 x 8	224	280	5 x 9	266	336
1 x 13	266	336	2 x 6	164	204	3 x 3.5	138	171	3.5 x 10	258	325	5 x 10	282	358
1 x 14	282	358	2 x 7	181	225	3 x 4	147	182	4 x 4	164	204	5 x 11	301	380
1 x 15	301	380	2 x 8	198	247	3 x 5	164	204	4 x 5	181	225	5 x 12	318	401
1.5 x 1.5	78	93	2 x 9	214	270	3 x 6	181	225	4 x 6	198	247	6 x 6	232	292
1.5 x 2	88	105	2 x 10	232	292	3 x 7	198	247	4 x 7	214	270	6 x 7	249	314
1.5 x 2.5	96	116	2 x 11	249	314	3 x 8	214	270	4 x 8	232	292	6 x 8	266	336
1.5 x 3	104	126	2 x 12	266	336									

Included in Sign Cabinet Kit Pricing:

- Mill finish or Pre-painted.
- Four (4) pieces of cut to size and mitered Single Face Filler, Part #2034.
- Four (4) pieces of cut to size and mitered Extended Econo Molding, Part #2058.
- Sixteen (16) Corner Keys, Part #5210.
- Thirty-two (32) Corner Key Screws, Part #5217.
- One (1) Molding Screws, Part #5217 for every perimeter foot of Extended Econo Molding.
- Packaging.

Kit Sizes and Availability:

- It is recommended to order kits 1" over nominal T-12 lamp size to utilize .040 Flat Aluminum Raceway Covers.
- Custom size kits may be cut to any dimension.

Recommended Lamp Spacing:

- For flat plastic, illuminated backgrounds - 10" on center, using T-12 lamps.
- For pan formed faces use guideline for T-12 lamp spacing, see General Information on page 2.
- Always place lamps 3/4" from back of sign.

Not included in Sign Cabinet Kit Pricing:

- Face and Back.
- Raceway Covers.
- Raceway Cover Screws.
- Ballast Brackets.
- Corner Angles - Not required for assembly.
- Electrical Components.
- Structural Supports.

General Information:

- Finishes: See page 2.
- Additional information: See page 2.
- Cut to size and pre-cut kits are available locally through select sign supply distributors.
- Extended Econo Molding Part #2058, is not engineered to directly integrate with the Econo Divider, Part #2140. Minimal additional assembly is required using Extended Divider Angle, Part #5335. See page 11.



Unassembled 5" Double Face Kits - For Rigid Faces

Medium Double Face Filler with Econo Molding

Part #2036

Part #2056

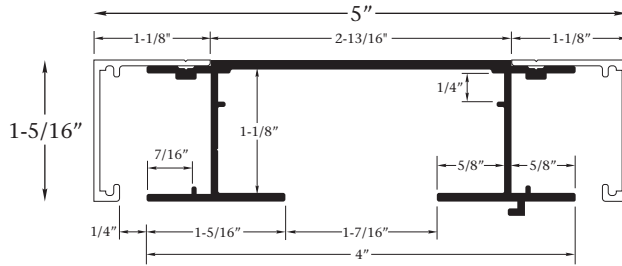

Size H x W	Mill Finish	Pre- Paint	Size H x W	Mill Finish	Pre- Paint	Size H x W	Mill Finish	Pre- Paint	Size H x W	Mill Finish	Pre- Paint	Size H x W	Mill Finish	Pre- Paint
1 x 1	\$51	\$60	1.5 x 3.5	\$93	\$114	2 x 13	\$233	\$296	3 x 9	\$190	\$243	4 x 9	\$ 205	\$260
1 x 2	66	79	1.5 x 4	102	124	2 x 14	248	315	3 x 10	205	260	4 x 10	219	278
1 x 3	79	97	1.5 x 5	116	142	2 x 15	261	333	3 x 11	219	278	4 x 11	233	296
1 x 4	93	114	1.5 x 6	128	162	2.5 x 2.5	93	114	3 x 12	233	296	4 x 12	248	315
1 x 5	108	133	1.5 x 8	157	196	2.5 x 3	102	124	3 x 13	248	315	4 x 13	261	333
1 x 6	122	151	1.5 x 10	184	232	2.5 x 3.5	108	133	3 x 14	261	333	4 x 14	276	351
1 x 7	136	170	2 x 2	79	97	2.5 x 4	116	142	3 x 15	276	351	4 x 15	290	369
1 x 8	150	187	2 x 2.5	88	107	2.5 x 5	128	162	3.5 x 3.5	122	151	5 x 5	164	205
1 x 9	164	205	2 x 3	93	114	2.5 x 6	142	180	3.5 x 4	128	162	5 x 6	179	224
1 x 10	179	224	2 x 3.5	102	124	2.5 x 8	170	214	3.5 x 5	142	180	5 x 7	190	243
1 x 11	190	243	2 x 4	108	133	2.5 x 10	199	251	3.5 x 6	157	196	5 x 8	205	260
1 x 12	205	260	2 x 5	122	151	3 x 3	108	133	3.5 x 8	184	232	5 x 9	219	278
1 x 13	219	278	2 x 6	136	170	3 x 3.5	116	142	3.5 x 10	213	269	5 x 10	233	296
1 x 14	233	296	2 x 7	150	187	3 x 4	122	151	4 x 4	136	170	5 x 11	248	315
1 x 15	248	315	2 x 8	164	205	3 x 5	136	170	4 x 5	150	187	5 x 12	261	333
1.5 x 1.5	66	79	2 x 9	179	224	3 x 6	150	187	4 x 6	164	205	6 x 6	190	243
1.5 x 2	73	89	2 x 10	190	243	3 x 7	164	205	4 x 7	179	224	6 x 7	205	260
1.5 x 2.5	79	97	2 x 11	205	260	3 x 8	179	224	4 x 8	190	243	6 x 8	219	278
1.5 x 3	88	107	2 x 12	219	278									

Included in Sign Cabinet Kit Pricing:

- Mill finish or Pre-painted.
- Four (4) pieces of cut to size and mitered Medium Double Face Filler, Part #2036.
- Eight (8) pieces of cut to size and mitered Econo Molding, Part #2056.
- Sixteen (16) Corner Keys, Part #5210.
- Thirty-two (32) Corner Key Screws, Part #5217.
- One (1) Molding Screws, Part #5217 for every perimeter foot of Econo Molding.
- Packaging.

Kit Sizes and Availability:

- It is recommended to order kits 1" over nominal T-12 lamp size to utilize .040 Flat Aluminum Raceway Covers.
- Custom size kits may be cut to any dimension.

Recommended Lamp Spacing:

- For flat or pan formed faces use guideline for T-12 lamp spacing, see General Information on page 2.

Not included in Sign Cabinet Kit Pricing:

- Faces.
- Raceway Covers.
- Raceway Cover Screws.
- Ballast Brackets.
- Corner Angles - Not required for assembly.
- Electrical Components.
- Structural Supports.

General Information:

- Finishes: See page 2.
- Additional information: See page 2.
- Cut to size and pre-cut kits are available locally through select sign supply distributors.
- Designed for use with Econo Divider: See page 11.



Unassembled 8" Double Face Kits - For Rigid Faces

Medium Double Face Filler with Extended Econo Molding

Part #2036

Part #2058

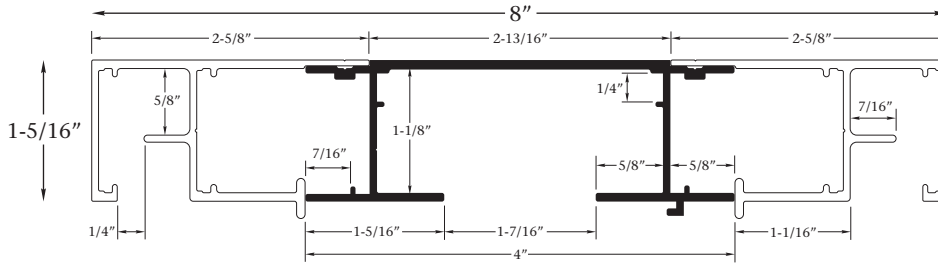

Size H x W	Mill Finish	Pre- Paint	Size H x W	Mill Finish	Pre- Paint	Size H x W	Mill Finish	Pre- Paint	Size H x W	Mill Finish	Pre- Paint	Size H x W	Mill Finish	Pre- Paint
1 x 1	\$76	\$90	1.5 x 3.5	\$148	\$183	2 x 13	\$389	\$492	3 x 9	\$317	\$400	4 x 9	\$340	\$431
1 x 2	100	121	1.5 x 4	159	199	2 x 14	413	524	3 x 10	340	431	4 x 10	366	462
1 x 3	123	151	1.5 x 5	184	229	2 x 15	438	556	3 x 11	366	462	4 x 11	389	492
1 x 4	148	183	1.5 x 6	209	261	2.5 x 2.5	148	183	3 x 12	389	492	4 x 12	413	524
1 x 5	172	214	1.5 x 8	257	322	2.5 x 3	159	199	3 x 13	413	524	4 x 13	438	556
1 x 6	197	245	1.5 x 10	304	384	2.5 x 3.5	172	214	3 x 14	438	556	4 x 14	461	585
1 x 7	220	277	2 x 2	123	151	2.5 x 4	184	229	3 x 15	461	585	4 x 15	486	617
1 x 8	244	306	2 x 2.5	136	167	2.5 x 5	209	261	3.5 x 3.5	197	245	5 x 5	269	338
1 x 9	269	338	2 x 3	148	183	2.5 x 6	232	290	3.5 x 4	209	261	5 x 6	292	369
1 x 10	292	369	2 x 3.5	159	199	2.5 x 8	280	353	3.5 x 5	232	290	5 x 7	317	400
1 x 11	317	400	2 x 4	172	214	2.5 x 10	328	416	3.5 x 6	257	322	5 x 8	340	431
1 x 12	340	431	2 x 5	197	245	3 x 3	172	214	3.5 x 8	304	384	5 x 9	366	462
1 x 13	366	462	2 x 6	220	277	3 x 3.5	184	229	3.5 x 10	353	446	5 x 10	389	492
1 x 14	389	492	2 x 7	244	306	3 x 4	197	245	4 x 4	220	277	5 x 11	413	524
1 x 15	413	524	2 x 8	269	338	3 x 5	220	277	4 x 5	244	306	5 x 12	438	556
1.5 x 1.5	100	121	2 x 9	292	369	3 x 6	244	306	4 x 6	269	338	6 x 6	317	400
1.5 x 2	111	137	2 x 10	317	400	3 x 7	269	338	4 x 7	292	369	6 x 7	340	431
1.5 x 2.5	123	151	2 x 11	340	431	3 x 8	292	369	4 x 8	317	400	6 x 8	366	462
1.5 x 3	136	167	2 x 12	366	462									

Included in Sign Cabinet Kit Pricing:

- Mill finish or Pre-painted.
- Four (4) pieces of cut to size and mitered Medium Double Face Filler, Part #2036.
- Eight (8) pieces of cut to size and mitered Extended Econo Molding, Part #2058.
- Twenty-four (24) Corner Keys, Part #5210.
- Thirty-two (32) Corner Key Screws, Part #5217.
- One (1) Molding Screws, Part #5217 for every perimeter foot of Extended Econo Molding.
- Packaging.

Kit Sizes and Availability:

- It is recommended to order kits 1" over nominal T-12 lamp size to utilize .040 Flat Aluminum Raceway Covers.
- Custom size kits may be cut to any dimension.

Recommended Lamp Spacing:

- For flat or pan formed faces use guideline for T-12 lamp spacing, see General Information on page 2.

Not included in Sign Cabinet Kit Pricing:

- Faces.
- Raceway Covers.
- Raceway Cover Screws.
- Ballast Brackets.
- Corner Angles - Not required for assembly.
- Electrical Components.
- Structural Supports.

General Information:

- Finishes: See page 2.
- Additional information: See page 2.
- Cut to size and pre-cut kits are available locally through select sign supply distributors.
- Extended Econo Molding Part #2058, is not engineered to directly integrate with the Econo Divider, Part #2140. Minimal additional assembly is required using Extended Divider Angle, Part #5335. See page 11.



Unassembled 9" Double Face Kits - For Rigid Faces

Large Double Face Filler with Econo Molding

Part #2032

Part #2056

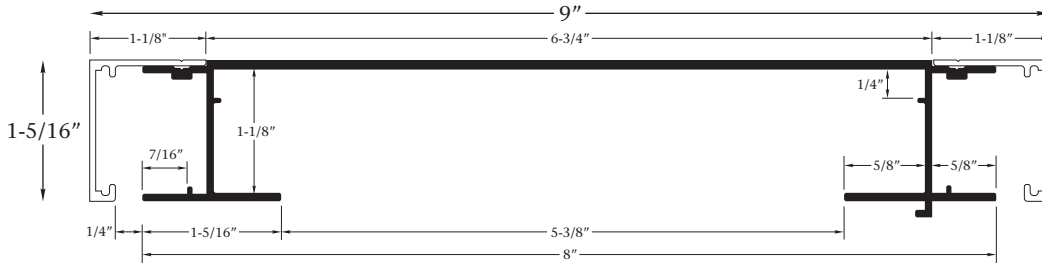

Size H x W	Mill Finish	Pre- Paint	Size H x W	Mill Finish	Pre- Paint	Size H x W	Mill Finish	Pre- Paint	Size H x W	Mill Finish	Pre- Paint	Size H x W	Mill Finish	Pre- Paint
1 x 1	\$61	\$73	1.5 x 3.5	\$117	\$146	2 x 13	\$304	\$387	3 x 9	\$248	\$315	4 x 9	\$268	\$338
1 x 2	79	97	1.5 x 4	127	157	2 x 14	322	411	3 x 10	268	338	4 x 10	286	363
1 x 3	98	121	1.5 x 5	146	182	2 x 15	341	435	3 x 11	286	363	4 x 11	304	387
1 x 4	117	146	1.5 x 6	164	205	2.5 x 2.5	117	146	3 x 12	304	387	4 x 12	322	411
1 x 5	136	170	1.5 x 8	201	255	2.5 x 3	127	157	3 x 13	322	411	4 x 13	341	435
1 x 6	153	194	1.5 x 10	239	303	2.5 x 3.5	136	170	3 x 14	341	435	4 x 14	360	459
1 x 7	172	219	2 x 2	98	121	2.5 x 4	146	182	3 x 15	360	459	4 x 15	379	484
1 x 8	193	243	2 x 2.5	108	133	2.5 x 5	164	205	3.5 x 3.5	153	194	5 x 5	210	265
1 x 9	210	265	2 x 3	117	146	2.5 x 6	182	230	3.5 x 4	164	205	5 x 6	230	290
1 x 10	230	290	2 x 3.5	127	157	2.5 x 8	219	278	3.5 x 5	182	230	5 x 7	248	315
1 x 11	248	315	2 x 4	136	170	2.5 x 10	257	326	3.5 x 6	201	255	5 x 8	268	338
1 x 12	268	338	2 x 5	153	194	3 x 3	136	170	3.5 x 8	239	303	5 x 9	286	363
1 x 13	286	363	2 x 6	172	219	3 x 3.5	146	182	3.5 x 10	276	351	5 x 10	304	387
1 x 14	304	387	2 x 7	193	243	3 x 4	153	194	4 x 4	172	219	5 x 11	322	411
1 x 15	322	411	2 x 8	210	265	3 x 5	172	219	4 x 5	193	243	5 x 12	341	435
1.5 x 1.5	79	97	2 x 9	230	290	3 x 6	193	243	4 x 6	210	265	6 x 6	248	315
1.5 x 2	90	109	2 x 10	248	315	3 x 7	210	265	4 x 7	230	290	6 x 7	268	338
1.5 x 2.5	98	121	2 x 11	268	338	3 x 8	230	290	4 x 8	248	315	6 x 8	286	363
1.5 x 3	108	133	2 x 12	286	363									

Included in Sign Cabinet Kit Pricing:

- Mill finish or Pre-painted.
- Four (4) pieces of cut to size and mitered Large Double Face Filler, Part #2032.
- Eight (8) pieces of cut to size and mitered Econo Molding, Part #2056.
- Sixteen (16) Corner Keys, Part #5210.
- Thirty-two (32) Corner Key Screws, Part #5217.
- One (1) Molding Screws, Part #5217 for every perimeter foot of Econo Molding.
- Packaging.

Kit Sizes and Availability:

- It is recommended to order kits 1" over nominal T-12 lamp size to utilize .040 Flat Aluminum Raceway Covers.
- Custom size kits may be cut to any dimension.

Recommended Lamp Spacing:

- For flat plastic, illuminated backgrounds - 7" on center, using T-12 lamps.
- For pan formed faces use guideline for T-12 lamp spacing, see General Information on page 2.

Not included in Sign Cabinet Kit Pricing:

- Faces.
- Raceway Covers.
- Raceway Cover Screws.
- Ballast Brackets.
- Corner Angles - Not required for assembly.
- Electrical Components.
- Structural Supports.

General Information:

- Finishes: See page 2.
- Additional information: See page 2.
- Cut to size and pre-cut kits are available locally through select sign supply distributors.
- Designed for use with Econo Divider: See page 11.



Unassembled 12" Double Face Kits - For Rigid Faces

Large Double Face Filler with Extended Econo Molding

Part #2032

Part #2058

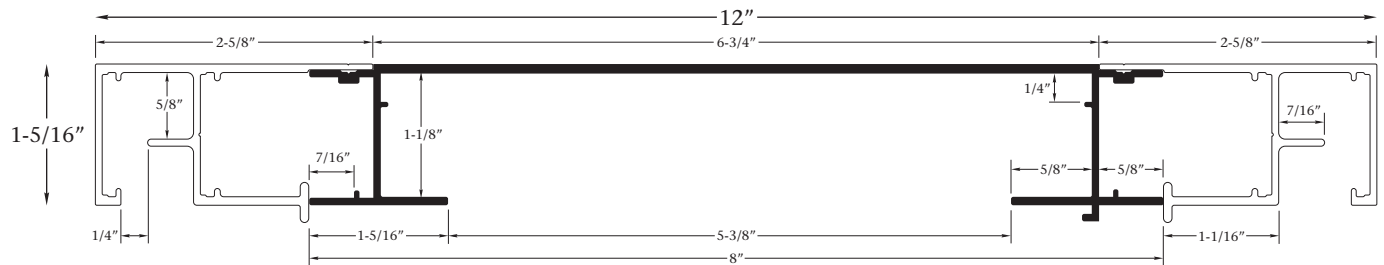

Size H x W	Mill Finish	Pre- Paint	Size H x W	Mill Finish	Pre- Paint	Size H x W	Mill Finish	Pre- Paint	Size H x W	Mill Finish	Pre- Paint	Size H x W	Mill Finish	Pre- Paint
1 x 1	\$85	\$102	1.5 x 3.5	\$171	\$213	2 x 13	\$459	\$584	3 x 9	\$372	\$473	4 x 9	\$401	\$509
1 x 2	113	139	1.5 x 4	185	231	2 x 14	488	622	3 x 10	401	509	4 x 10	430	547
1 x 3	142	175	1.5 x 5	214	269	2 x 15	517	658	3 x 11	430	547	4 x 11	459	584
1 x 4	171	213	1.5 x 6	243	305	2.5 x 2.5	171	213	3 x 12	459	584	4 x 12	488	622
1 x 5	200	249	1.5 x 8	301	380	2.5 x 3	185	231	3 x 13	488	622	4 x 13	517	658
1 x 6	229	287	1.5 x 10	358	454	2.5 x 3.5	200	249	3 x 14	517	658	4 x 14	546	696
1 x 7	258	323	2 x 2	142	175	2.5 x 4	214	269	3 x 15	546	696	4 x 15	575	732
1 x 8	287	362	2 x 2.5	156	195	2.5 x 5	243	305	3.5 x 3.5	229	287	5 x 5	316	399
1 x 9	316	399	2 x 3	171	213	2.5 x 6	272	343	3.5 x 4	243	305	5 x 6	345	435
1 x 10	345	435	2 x 3.5	185	231	2.5 x 8	330	417	3.5 x 5	272	343	5 x 7	372	473
1 x 11	372	473	2 x 4	200	249	2.5 x 10	387	491	3.5 x 6	301	380	5 x 8	401	509
1 x 12	401	509	2 x 5	229	287	3 x 3	200	249	3.5 x 8	358	454	5 x 9	430	547
1 x 13	430	547	2 x 6	258	323	3 x 3.5	214	269	3.5 x 10	416	528	5 x 10	459	584
1 x 14	459	584	2 x 7	287	362	3 x 4	229	287	4 x 4	258	323	5 x 11	488	622
1 x 15	488	622	2 x 8	316	399	3 x 5	258	323	4 x 5	287	362	5 x 12	517	658
1.5 x 1.5	113	139	2 x 9	345	435	3 x 6	287	362	4 x 6	316	399	6 x 6	372	473
1.5 x 2	128	157	2 x 10	372	473	3 x 7	316	399	4 x 7	345	435	6 x 7	401	509
1.5 x 2.5	142	175	2 x 11	401	509	3 x 8	345	435	4 x 8	372	473	6 x 8	430	547
1.5 x 3	156	195	2 x 12	430	547									

Included in Sign Cabinet Kit Pricing:

- Mill finish or Pre-painted.
- Four (4) pieces of cut to size and mitered Large Double Face Filler, Part #2032.
- Eight (8) pieces of cut to size and mitered Extended Econo Molding, Part #2058.
- Twenty-four (24) Corner Keys, Part #5210.
- Thirty-two (32) Corner Key Screws, Part #5217.
- One (1) Molding Screws, Part #5217 for every perimeter foot of Extended Econo Molding.
- Packaging.

Kit Sizes and Availability:

- It is recommended to order kits 1" over nominal T-12 lamp size to utilize .040 Flat Aluminum Raceway Covers.
- Custom size kits may be cut to any dimension.

Recommended Lamp Spacing:

- For flat plastic, illuminated backgrounds - 10" on center, using T-12 lamps.
- For pan formed faces use guideline for T-12 lamp spacing, see General Information on page 2.

Not included in Sign Cabinet Kit Pricing:

- Faces.
- Raceway Covers.
- Raceway Cover Screws.
- Ballast Brackets.
- Corner Angles - Not required for assembly.
- Electrical Components.
- Structural Supports.

General Information:

- Finishes: See page 2.
- Additional information: See page 2.
- Cut to size and pre-cut kits are available locally through select sign supply distributors.
- Extended Econo Molding Part #2058, is not engineered to directly integrate with the Econo Divider, Part #2140. Minimal additional assembly is required using Extended Divider Angle, Part #5335. See page 11.



EconoComp Instructions

Corner Assembly

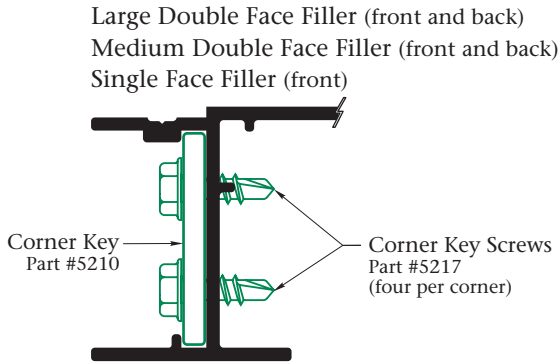

1. Insert Corner Keys, part #5210 into extruded slots, two (2) per corner.
2. Fasten Corner Key, part #5210 to Filler with Corner Key Screws, part #5217, four (4) per corner.
3. Use opaque silicone to caulk inside of mitered corners.

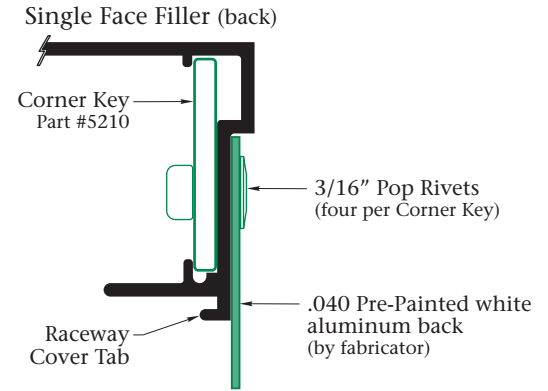

Note: Be sure to align Raceway Cover Tabs prior to cutting and/or assembly.

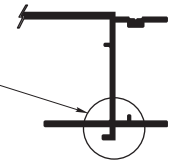

Molding Assembly

1. Drill 1/8" pilot holes along extruded scribe line located on molding surface. Placement of the pilot holes should be approximately 2" from each corner and 18" on center.
2. Insert Molding Screw, part #5217. **DO NOT** over tighten.
Hint: Use beeswax to lubricate Molding Screw insertion.

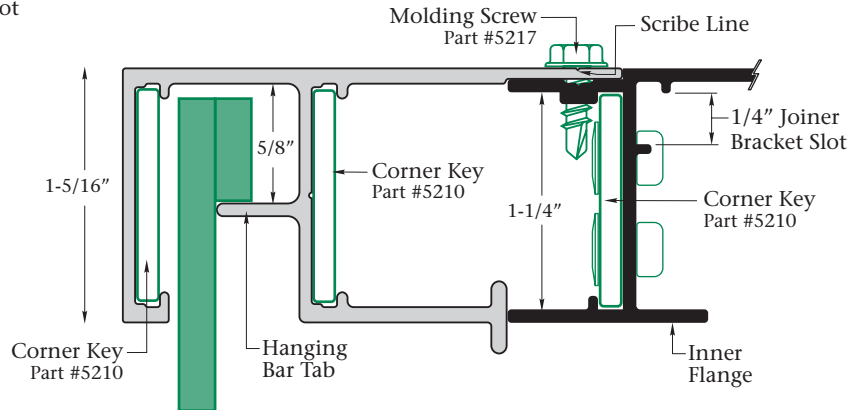
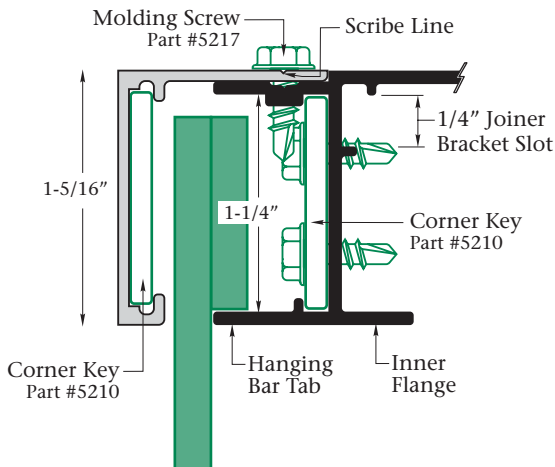

Raceway Covers

Large Double Face Filler
 Part #2032



Raceway Cover Blank
 6-1/2" x 48" x .040" (white)
 Part #5088

Medium Double Face Filler
 Part #2036



Raceway Cover Blank
 3" x 48" x .040" (white)
 Part #5085

Single Face Filler
 Part #2034



Raceway Cover Blank
 5-1/8" x 48" x .040" (white)
 Part #5084



EconoComp Instructions

1-5/16" Econo Divider

Fig. A

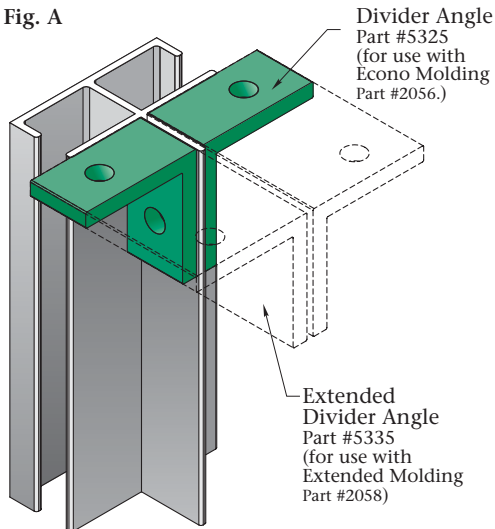

1. Position and clamp two (2) Divider Angles flush with the end of the Econo Divider, Part #2140. **Note: When using the Econo Molding, Part #2056 use the Divider Angle, Part #5325. When using the Extended Econo Molding, Part #2058, use the Extended Divider Angle. Part #5335. See Fig. A.**
2. Drill an 1/8" pilot hole through the Divider Angles and Econo Divider, Part #2140.
3. Insert the #8 x 1/2" Divider Screws, Part #5217 into the pre-drilled 1/8" hole
4. Repeat steps 1-3 on opposite end of the Econo Divider, Part #2140.
5. Position and clamp the Econo Divider, Part #2140 to the Inner Flange of the Filler so the face of the Econo Divider, Part #2140 is flush with the face of the Econo Molding, Part #2056 or the Extended Molding, Part #2058 at each end. See Fig. B. **Note: When using the Extended Molding, Part #2058 the back leg will need to be notched to allow the Econo Divider, Part #2140 and Extended Divider Angles, Part #5335 to be flush with the Extended Molding. See Fig. B.**
6. Drill 1/8" pilot hole through the Divider Angle and Inner Flange.
7. Insert the #8 x 1/2" Divider Screw, Part #5217 into the pre-drilled 1/8" hole.

Fig. B

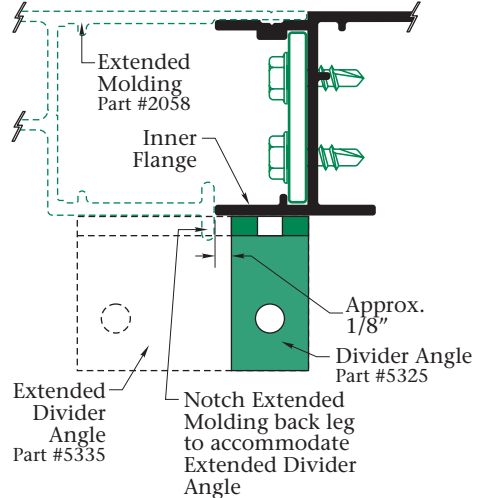

Note: 1-5/16" Econo Divider is engineered for use with the Econo Molding. To use the 1-5/16" Econo Divider with the Extended Econo Molding, attach the Econo Divider to the Inner Flange using the Extended Divider Angle, part #5335 as noted and shown above.

Additional Information

Freight Policy

- The freight shall be prepaid, F.O.B. Grand Rapids, Michigan for single orders of extrusions and/or accessories whereby the invoiced amount is \$5,000.00 or more to any single destination within the continental United States or Canada.
- The freight shall be collect, F.O.B. Grand Rapids, Michigan for all orders other than as stated in this freight policy.
- All freight claims for freight collect shipments are the sole responsibility of the buyer.
- Any requests for expedited freight services shall be the sole expense of the buyer.
- Combining stock items with custom run items qualifies for freight prepaid status only when all items ship as one shipment.

Minimum Order

- Any single full length extrusion profile and/or prepackaged accessories.
- Any single kit.

Availability

- Typical extrusion and accessory orders ship within three (3) days upon receipt and acceptance of your purchase order.
- All orders will receive an approximate ship date upon receipt and acceptance of the written purchase order and confirmation.

Return Policy

- Returns of SignComp products will not be accepted without prior authorization and written RMA number from SignComp.
- Materials may not be returned for any reason other than defective product or incorrect fulfillment of order.
- All goods to be returned must be acknowledged in writing within the 60 day grace period from the date of the shipment. Any claims after this period will be considered invalid.
- All returned goods **must be in new and saleable condition** for full credit to be issued.

Additional Product Offerings

- Custom extrusions. Mill shipment programs.
- Pre-painted and cut to length extrusion programs.

Backorder Policy

- In the very unlikely event of a back order, the back order will be shipped freight prepaid only if the original order qualified for freight prepaid status.
- Additional materials may be added to any back order, shipped freight prepaid with the additional freight expense the responsibility of the buyer.
- Any expedited freight service requested by the buyer shall be at the expense of the buyer.

Exclusive Warranty and Remedies

- In effect as of January 1, 2008.
- This is the exclusive warranty policy of SignComp, LLC, Grand Rapids, Michigan 49544 (the "Company") with respect to any and all of its products.

EXCLUSIVE WARRANTY

- The Company warrants you as the original purchaser that the Company's products will be free from defects in materials and workmanship, under normal conditions, upon shipment of said products from the Company, for 30 days.
- This exclusive warranty does not apply to damage caused by improper handling. The company shall have no liability or responsibility for any damage whatsoever caused by handling.
- The Company hereby disclaims any and all other warranties, including, without limitation, implied warranties of merchantability and fitness for a particular purpose. The only warranty with respect to the Company's products is described in this exclusive warranty. No oral or written representations shall extend the Company's exclusive warranty beyond the description herein.

WARRANTY PROCEDURES

- The purchaser must notify the Company of any warranty claim prior to initiating any remedy upon the defective product. Upon receipt of such notice, the Company will direct that an authorized representative inspect the product and, if necessary, correct the defect in accordance with this exclusive warranty. The Company shall have the exclusive right to determine whether or not a defect is covered by this exclusive warranty.

REMEDIES

- Provided that the warranty procedures are followed, the Company will repair and/or replace the defective SignComp product(s) during the applicable warranty period without charge for parts or labor.
- Repair and/or replacement of defective SignComp products is your exclusive remedy under the Company's exclusive warranty.
- The Company shall not be liable for any incidental or consequential damages if the Company's product is defective or does not conform to this exclusive warranty. In any event the maximum amount for which the Company shall be liable to the purchaser shall be the original purchase price of the defective SignComp product(s).
- Any claim for breach of this exclusive warranty shall be brought, if at all, no later than 30 days from the Company's breach.

ADDRESS FOR NOTIFICATION

- Notice of a product defect covered by this exclusive warranty can be made in writing or by telephone. The Company's address and telephone number are:

SignComp, LLC, 3032 Walker Ridge Dr. NW, Grand Rapids, MI 49544
 Attention: Customer Service - Phone: (616) 784-0405
 Toll Free: (877) 784-0405
 Fax: (616) 784-0411
 e-mail: signcomp@signcomp.com



**3032 Walker Ridge Dr. NW
Grand Rapids, MI 49544
U.S.A.
toll free: (877) 784-0405 (US and Canada)
local: (616) 784-0405
fax: (616) 784-0411
e-mail: signcomp@signcomp.com
www.signcomp.com**

© 2008 SignComp LLC.